

FAG

3209-BD-XL-TVH-C3

Angular contact ball bearing

Schaeffler ID:
0627748400030

Angular contact ball bearing 32..-BD-XL-TVH, double row, X-life, plastic cage

X-life

Technical information

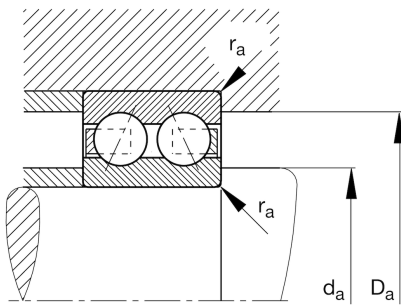
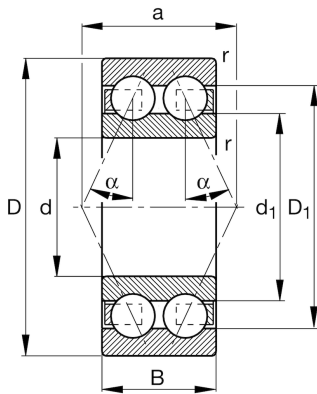

Main Dimensions & Performance Data

d	45 mm	Bore diameter
D	85 mm	Outside diameter
B	30.2 mm	Width
C_r	50,000 N	Basic dynamic load rating, radial
C_{0r}	39,000 N	Basic static load rating, radial
C_{ur}	2,700 N	Fatigue load limit, radial
n_G	8,300 1/min	Limiting speed
n_{gr}	8,400 1/min	Reference speed
	0.611 kg	Weight

Mounting dimensions

$d_{a \min}$	52 mm	Minimum diameter shaft shoulder
$D_{a \max}$	78 mm	Maximum diameter of housing shoulder
$r_{a \max}$	1 mm	Maximum fillet radius

Dimensions

r_{\min}	1.1 mm	Minimum chamfer dimension
D_1	75.1 mm	Shoulder diameter outer ring
d_1	59.9 mm	Shoulder diameter inner ring
a	50.3 mm	Distance between the apexes of the pressure cones
α	30 °	Contact angle

Temperature range

T_{\min}	-30 °C	Operating temperature min.
T_{\max}	120 °C	Operating temperature max.